



Product: PC3000	March 13, 2013
Version: See Version Information Section	
Product Bulletin # 27	

PLC/HMI Software Upgrade

Version Information

PLC Program Revised: PLC_PC3000_02_14_04

HMI Program Revised: NT_P3_04_03

PLC Program Released: PLC_PC3000_02_15_04

HMI Program Released: NT_P3_04_06

Models Impacted

Canrig PC3000 Automated Catwalk series, Serial Number 300354 and newer.

Summary of Changes

Software version number PLC_PC3000_02_15_04/NT_P3_04_06 is a major upgrade for the PC3000 system and replaces the previous version.

Software Changes and Enhancements

Improvements have been made to the PLC/HMI software used in the Canrig PC3000 Automated Catwalk. This program bulletin lists the new functionality and changes to the software.

Panel Control and E-STOP Activation

Press and hold the RESET button on the panel console (Figure 2) for three seconds to enable the panel console. This affects the radio console (Figure 1) in either of two ways:

- If the radio console was ON at switchover, only the E-STOP button, RESET button, and Terminal OFF switch on the radio console remain active. The E-STOP button and Terminal OFF switch will shut OFF the pump motor if actuated.
- If the radio console was OFF at switchover, only the Terminal ON switch remains active. The E-STOP button on the radio console remains inactive until control is re-assumed by the radio console when the Terminal ON switch and RESET button are actuated.

Pressing and holding the RESET button on the radio console (Figure 1) for three seconds enables the radio console and deactivates all controls on the panel console except the E-STOP and RESET buttons.



NOTE

The Hyd. Motor AUTO/HAND selector switch is wired outside the PLC controls and remains active.

Upon startup, if neither console is enabled with the RESET button selected, the PLC enables the panel console by default.

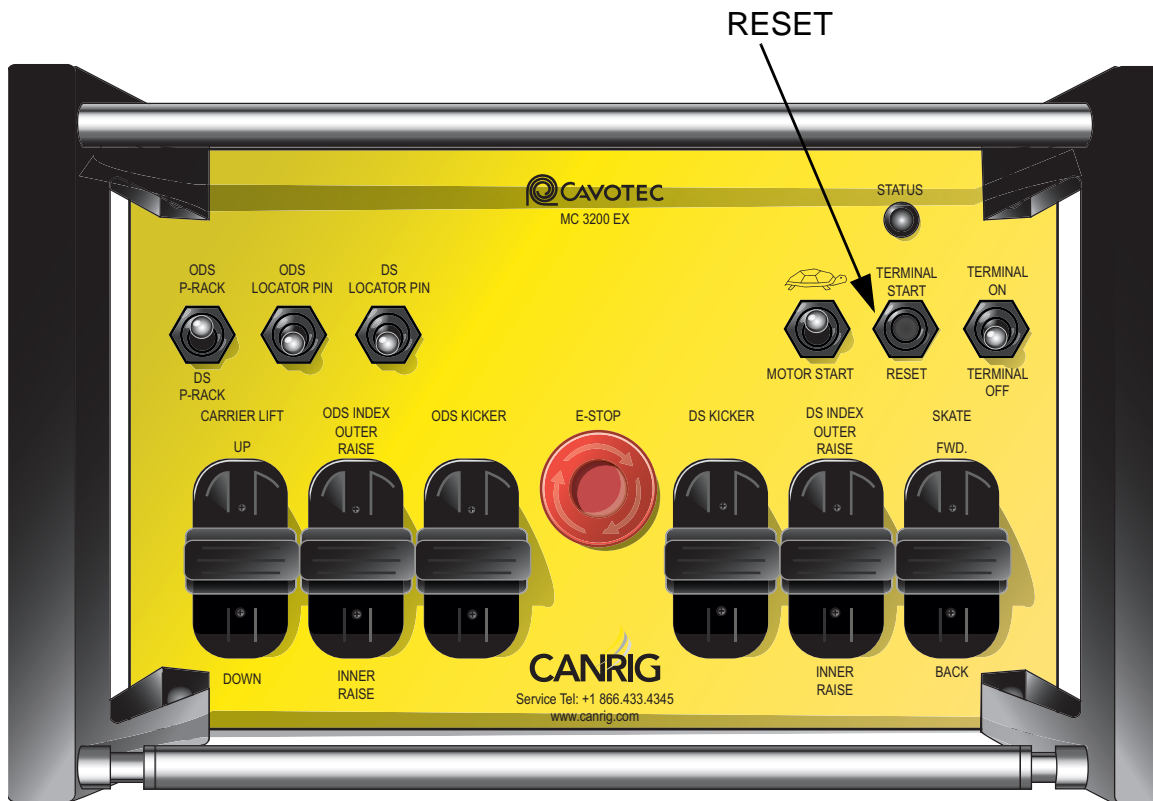

Figure 1: Radio Console

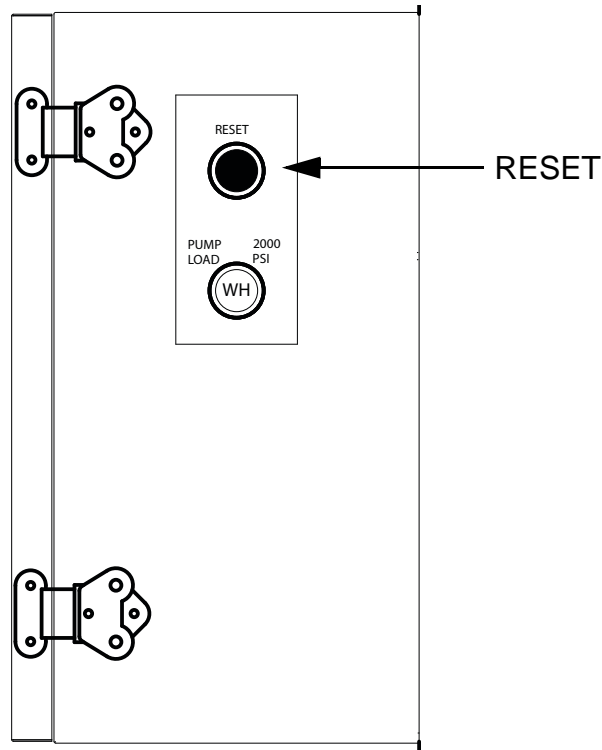

Figure 2: Panel Console – Right Side View

New Ramp Positioning Function

The new Ramp Positioning [Ramp Pos – F4] function HMI screen (Figure 3, page 4) has been added to enable pump pressure to be set while raising or lowering the ramp on units equipped with the hydraulic ramp option. F4 turns ON and OFF the feature while on the screen. Pressure can be stepped up or down in 100-psi increments using F3 or F5 respectively. Alternatively, the desired pressure can be selected using F6 to switch to Setting mode. In Setting mode, F5 clears the value, F4 raises the first digit by ones, and F3 moves the ones-column one place to the left. The minimum pressure using Ramp Positioning is 2000 psi and the maximum is 3200 psi.

The PLC holds the last pressure selected in memory and defaults to that pressure. A 10-minute timer turns OFF the pump motor if nothing is being used. In this mode, only the following controls are enabled from the radio console and the panel console: E-STOP, RESET, START, STOP, DS PR Enable, DS Kicker UP/DOWN, (PR RAMP UP/DOWN, and Carrier UP/DOWN).

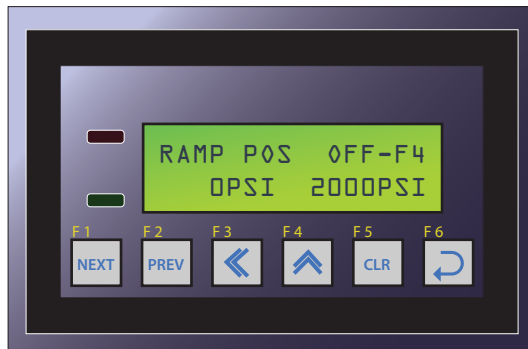

Figure 3: Ramp Positioning Function

New Auxiliary Winch Function

The new Auxiliary Winch [Aux Winch – F4] function HMI screen (Figure 4) has been added to allow pump pressure to be raised when operating a hold back winch, if one is installed. F4 turns ON and OFF the function while on the screen. Switching to a different screen or function turns OFF Auxiliary Winch. Pressure can be stepped up or down in 100-psi increments using F3 or F5 respectively. Alternatively, pressure can be selected using F6 to switch to Setting mode. In Setting mode, F5 clears the value, F4 raises the first digit by ones, and F3 moves the ones-column one place to the left. The minimum pressure using Auxiliary Winch is 500 psi and the maximum is 3000 psi. The PLC holds the last pressure selected in memory and defaults to that pressure. A 15-minute timer turns OFF Auxiliary Winch whether it is being used or not.



Figure 4: Auxiliary Winch Function

Improved Safety Curtain Blocked Function

The Safety Curtain Blocked HMI screen (Figure 5) now identifies which safety sensor (DS and/or ODS) is blocked. The error is displayed in real time and displays Sfty Curt-DS or Sfty Curt-ODS until the blockage is removed or the error is corrected. If both sensors are blocked, the screen displays Sfty Curt-DS ODS. Sensor and error functionality remain the same as in previous software versions.

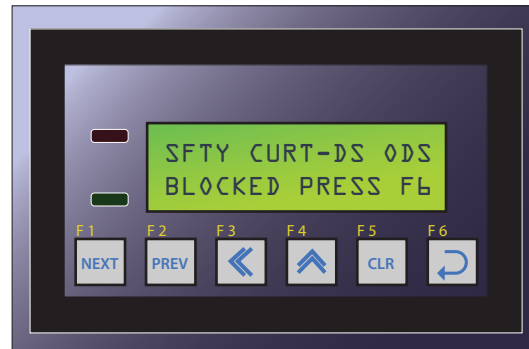

Figure 5: Safety Curtain Blocked Function

Temperature Unit Correction C/F

The incorrect display of temperature and units during a hot oil shutdown is now fixed.

Text Corrections

The misspelling on the Replace Winch Cables Soon message (Figure 6) has been corrected.



Figure 6: Replace Winch Cables Soon Message

Text for the Check Winch Encoder Wiring error message has been changed to Winch Encoder or Wiring Error (Figure 7).



Figure 7: Winch Encoder or Wiring Error Message

Heater Contactor Chattering Correction

The problem that caused the heater contactor to chatter at the Heater ON setpoint temperature has been corrected. Prior to this correction, when the E-STOP button was pressed and the ambient temperature dropped below the Heater ON setpoint temperature, the heater would cycle ON and OFF continuously as the heater contactor relay was alternately energized and de-energized.

Screen RESET

The RESET button returns the system to the Home screen from every screen except the Ramp Pos screen.

New Pressure Transducer(s) Error Messages

The Pressure Transducer error message has been replaced by three separate error messages to identify the failed transducer – system, catwalk load, or carrier load. If all three transducers fail, the error message Xducer Err Pump Shutdown is displayed (Figure 8).



Figure 8: New Pressure Transducer Error Messages

Pump Operation/Feedback Status Message

The error message Pump Not Running Check Motor (Figure 9) has been added. It is displayed if the feedback signal from the motor contactor is missing while power is being applied to the motor on the contactor coil.

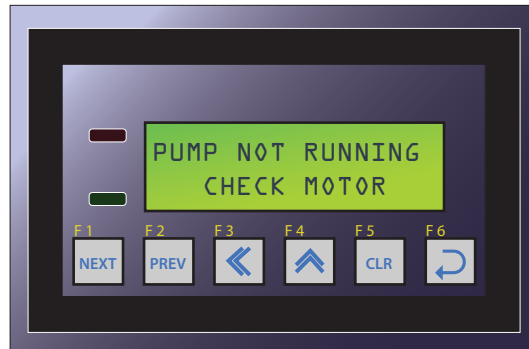

Figure 9: New Pump Operation/Feedback Status Error Message

Oil Circulate Mode Change

On the Home screen, the Oil Circulate feature no longer turns OFF when RESET is pressed. Oil Circulate now turns off automatically 15 minutes after it was turned on, or when F5 is pressed.

Return Oil Filter High Differential Oil Pressure Error Message

The logic for the Hyd Oil Filter Blocked error message has been modified. If the filter differential pressure is above the setpoint, the error message is now only displayed if oil temperature is also above the Cold Oil Warning setpoint. Previously, the message would display if the filter differential pressure was above the setpoint and the heater was turned ON.

New Hot Oil Warning Setpoint & Bypass Function

A Hot Oil Warning setpoint has been added (Figure 10). When oil temperature rises above the setpoint, the PLC shuts OFF the pump motor. The warning can be bypassed for 15 minutes by pressing F5 on the screen to allow the Operator to complete the current operation prior to troubleshooting the problem. Once the warning has been bypassed, the PLC will shut OFF the pump motor again after 15 minutes if the temperature stays above the setpoint. The Hot Oil Warning bypass will not override the pump motor shutdown if oil temperature reaches the Hot Oil shutdown setpoint.



Figure 10: Hot Oil Warning

New Default ISO Selection

The PLC program checks oil type selected during the first PLC scan cycle. If a valid selection has not been made, the PLC selects ISO13 by default (Figure 11).

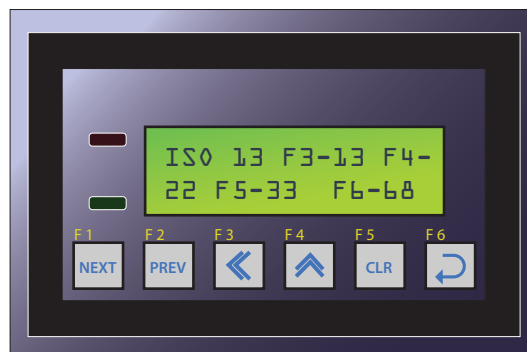

Figure 11: ISO Selection

New Default Catwalk Type Selection

The PLC program checks catwalk type selected during the first PLC scan cycle. If a valid selection has not been made, the PLC selects Standard by default.

Improved Cold Weather/Oil Circulation Warmup Message

In Cold Weather mode or during the oil circulation warmup sequence, the Home screen now displays OK-Circ./Coldwm instead of just OK (Figure 12). Error messages are disabled during the 15-minute warmup sequence.



Figure 12: Oil Circulation Warmup Message

Cold Weather Mode Change

In Cold Weather mode, the circulation valve opens and closes automatically depending on the oil used. For example, when ISO13 oil is used, the valve opens when oil temperature reaches 95° F (the fan start temperature for ISO13), and closes at 111° F (the hot temperature warning for ISO13) (Figure 13).

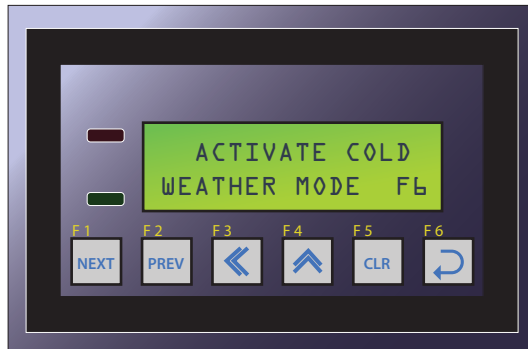

Figure 13: Cold Weather Mode Active

Recommendations

Contact Rigline 24/7 to inquire whether your Canrig PC3000 Automated Catwalk can be upgraded to the new PLC/HMI program software, and to schedule installation.